

STANDARD PRECAST MANHOLE
(ECCENTRIC CONE)
Not to Scale

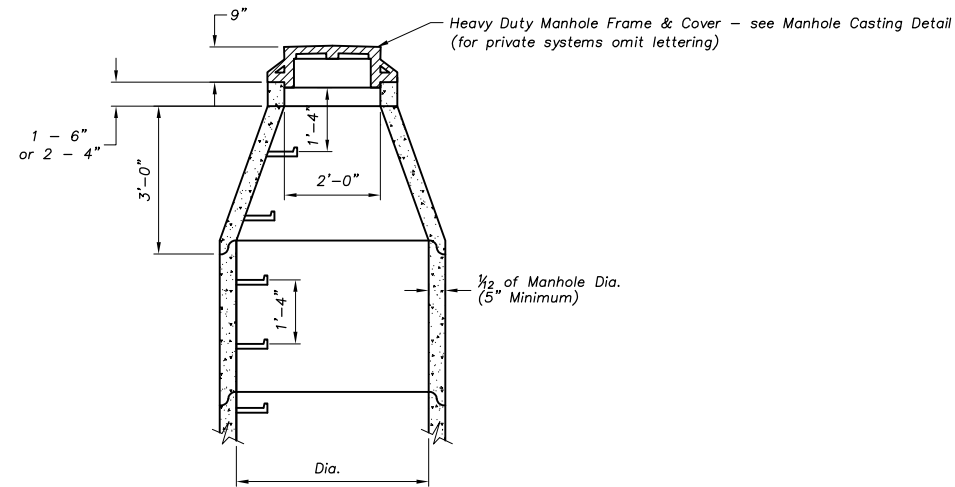

STANDARD PRECAST MANHOLE
(CONCENTRIC CONE)
(Shallow Manholes only)
Not to Scale

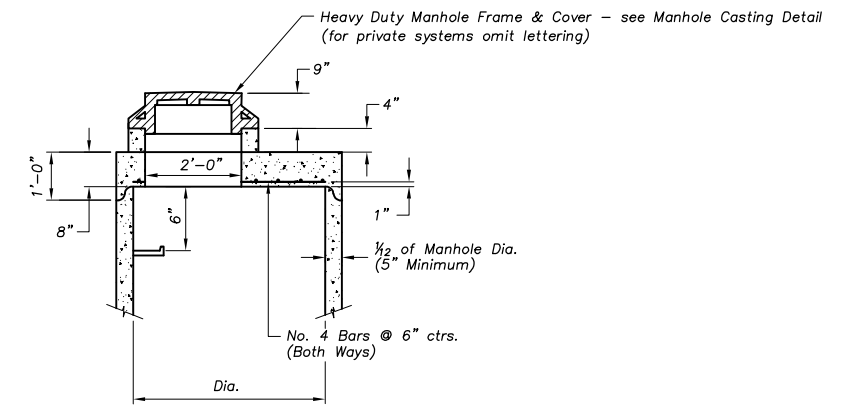

STANDARD PRECAST MANHOLE
(SHALLOW TYPE)
(To be Used Only When Specified in Plans)
Not to Scale

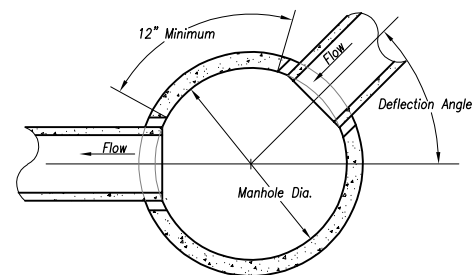

SECTION A-A
Not to Scale

Precast Manhole Notes

1. Overland Park Municipal Code (OPMC) and Overland Park Design and Construction Standards Manual (OPDCSM) are incorporated, except as otherwise noted.
2. The inside diameter of the manhole shall be 4'-0" for pipe diameters from 12" thru 24". All manhole bases (pre-cast or poured-in-place) shall have No. 4 reinforcing bars placed at 6" centers both ways.
3. All manhole rings and covers shown in plans shall be heavy duty.
4. Standard cast iron manhole steps or steel core, plastic coated steps may be used. See Approved Materials List for pre-approved steps.
5. Reinforcement in all sections shall equal or exceed A.S.T.M. C-478 specifications.
6. Mastic material to be used at all sections joints. O-rings may be used for joints below the cone section, but the cone section itself shall not have O-ring joints.
7. Approved gasket or concrete mortar to be used around pipe in knock-outs.
8. Pipe connections to pre-cast structures shall have a minimum of 6" of concrete around the entire pipe within 2' of the structure.

Year 2021 Edition

REVISIONS:	
05/10/01	Notes;
07/01/03	Miscellaneous;
Jan. 2006	Miscellaneous;
RELATED ORDINANCES:	
OPMC Title 15	

OVERLAND PARK
KANSAS
ABOVE AND BEYOND. BY DESIGN.

DEPARTMENT OF PUBLIC WORKS
STANDARD DETAILS

PRECAST MANHOLE DETAIL