

Standard Type "A" Curb

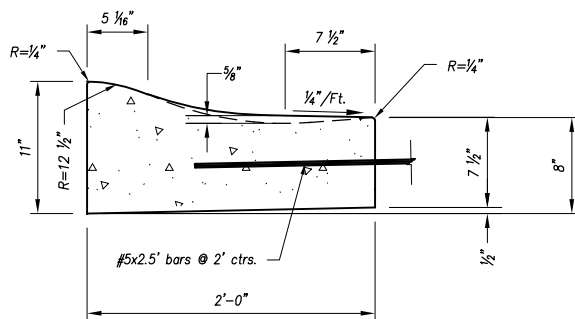

Type "A - Dry" Curb

NOTE: in transitions, water shall flow from the gutter of Type "A" curb to the lip of Type "A-Dry" curb at 0.5% min. slope.

Curb & Gutter Notes:

1. The Overland Park Municipal Code (OPMC) and Overland Park Design and Construction Standards Manual (OPDCSM) are incorporated, except as otherwise noted.
2. Contraction joints shall match the spacing and depth of the adjacent concrete panel.
3. All concrete used in this work shall meet the requirements of the OPMC. KCMMB4K Concrete shall be used throughout.
4. See sidewalk ramp details for typical sidewalk ramp curb & gutter sections.

CONCRETE CURB & GUTTER

Not to Scale

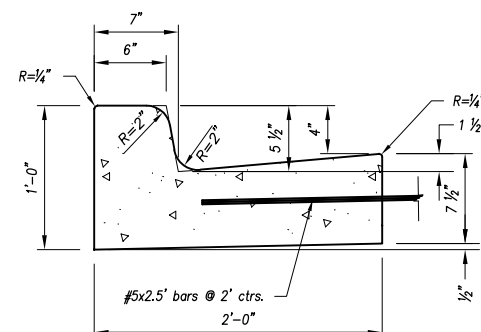

Standard Type "B" Curb

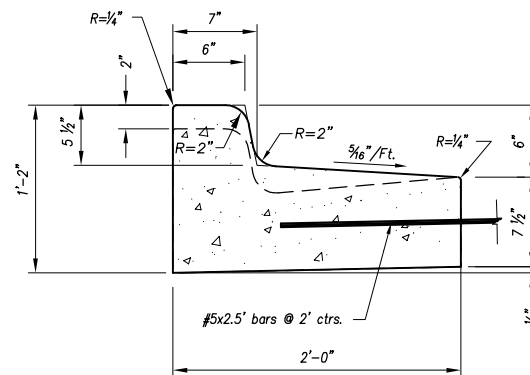

Type "B - Dry" Curb

NOTE: in transitions, water shall flow from the gutter of Type "B" curb to the lip of Type "B-Dry" curb at 0.5% min. slope.

Curb & Gutter Notes:

1. The Overland Park Municipal Code (OPMC) and Overland Park Design and Construction Standards Manual (OPDCSM) are incorporated, except as otherwise noted.
2. Contraction joints shall match the spacing and depth of the adjacent concrete panel.
3. All concrete used in this work shall meet the requirements of the OPMC. KCMMB4K Concrete shall be used throughout.
4. See sidewalk ramp details for typical sidewalk ramp curb & gutter sections.

CONCRETE CURB & GUTTER

Not to Scale

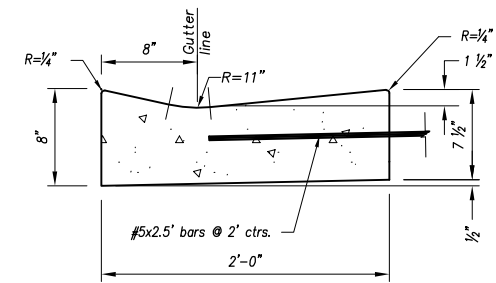

Standard Type "C" Curb*

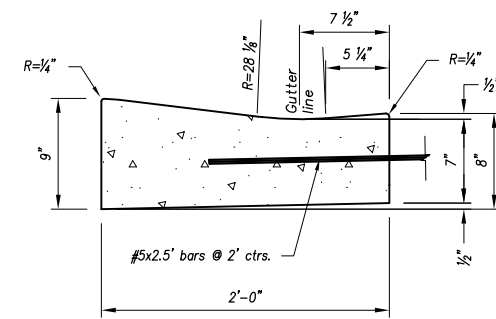

Type "C-1" Curb *

(Use w/ type "A" curb)

* Use for commercial entrances

Curb & Gutter Notes:

1. The Overland Park Municipal Code (OPMC) and Overland Park Design and Construction Standards Manual (OPDCSM) are incorporated, except as otherwise noted.
2. Contraction joints shall match the spacing and depth of the adjacent concrete panel.
3. All concrete used in this work shall meet the requirements of the OPMC. KCMMB4K Concrete shall be used throughout.
4. See sidewalk ramp details for typical sidewalk ramp curb & gutter sections.

CONCRETE CURB & GUTTER

Not to Scale

Year 2022 Edition

REVISIONS:	
RELATED ORDINANCES:	
OPMC Title 13	

OVERLAND PARK
KANSAS
ABOVE AND BEYOND. BY DESIGN.

DEPARTMENT OF PUBLIC WORKS
STANDARD DETAILS

CONCRETE CURB WITH CONCRETE PAVEMENT
(COLLECTOR AND RESIDENTIAL STREETS)

DATE: 01/28/2015

SHEET: 9