

Legend:

- Logitudinal Tied Joint
- - - Transverse Contraction Joint
- · - · - Untied Contraction Joint
- ▨ Placed Monolithically

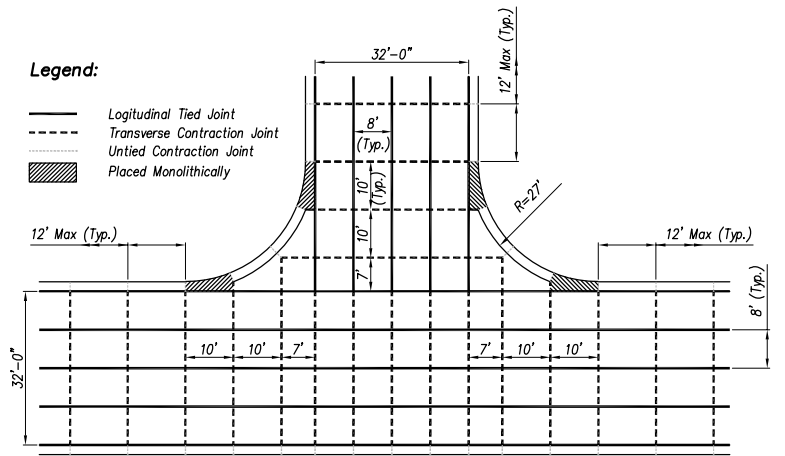

Typical Collector / Collector Intersection

Legend:

- Logitudinal Tied Joint
- - - Transverse Contraction Joint
- · - · - Untied Contraction Joint
- ▨ Placed Monolithically

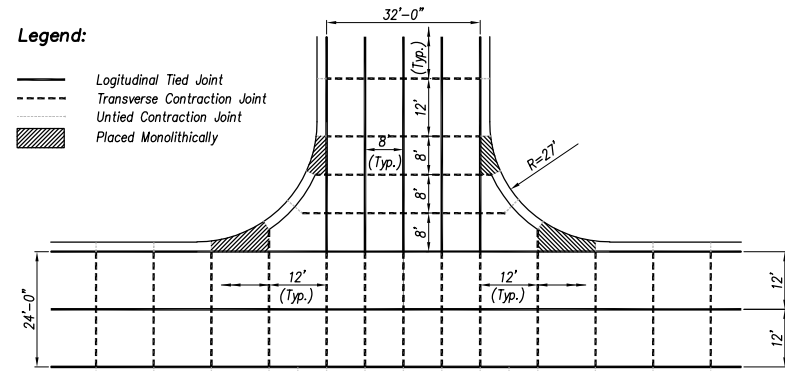

Typical Collector / Residential Intersection

Legend:

- Logitudinal Tied Joint
- - - Transverse Contraction Joint
- · - · - Untied Contraction Joint
- ▨ Placed Monolithically

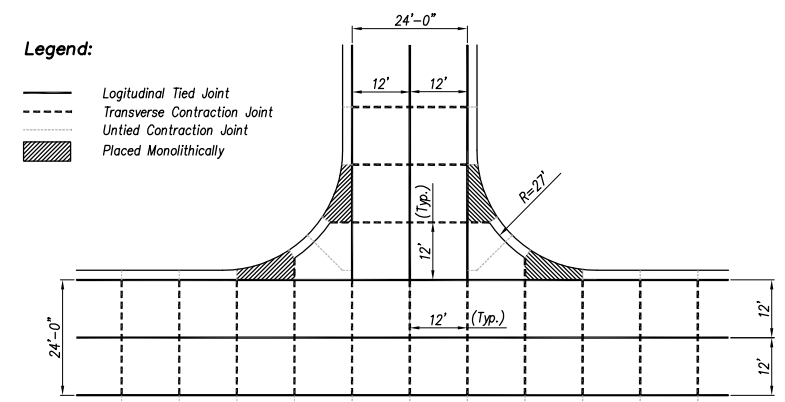

Typical Residential / Residential Intersection

Legend:

- Logitudinal Tied Joint
- - - Transverse Contraction Joint
- · - · - Untied Contraction Joint
- ▨ Placed Monolithically

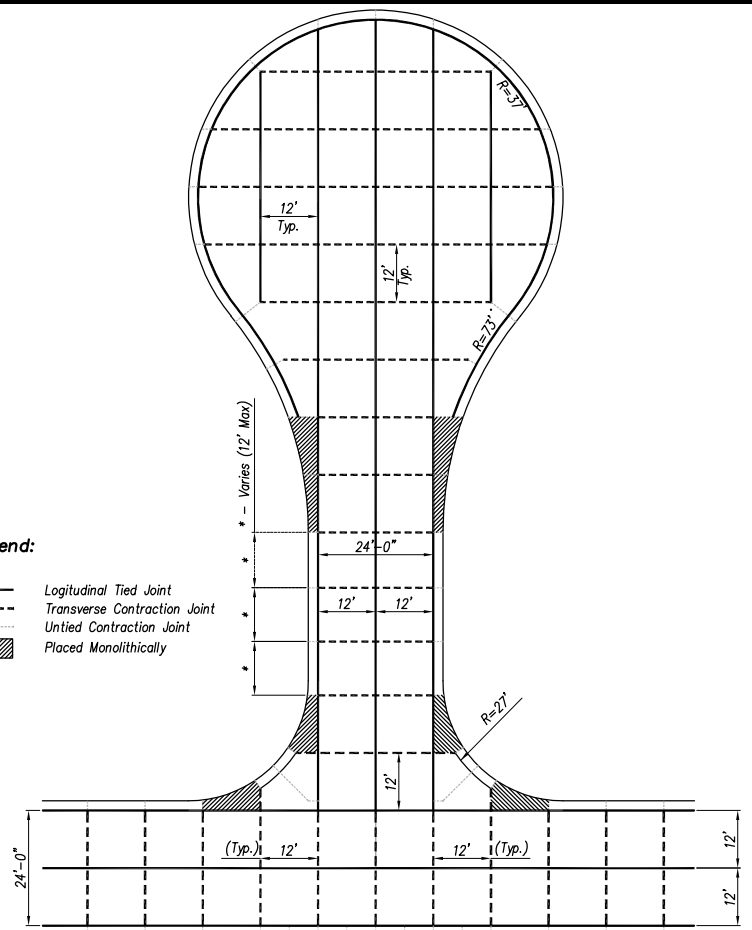

Typical Residential CDS (*)

(*) - Curb and Gutter may be placed monolithically

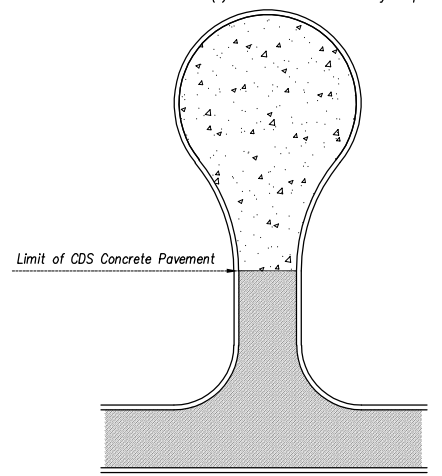

Concrete CDS at Asphalt Street

Legend:

- Logitudinal Tied Joint
- - - Transverse Contraction Joint
- · - · - Untied Contraction Joint
- ▨ Placed Monolithically

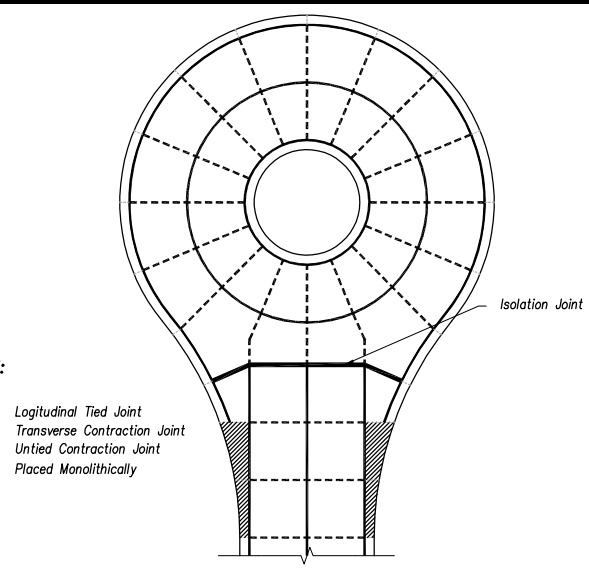

Residential CDS with Island

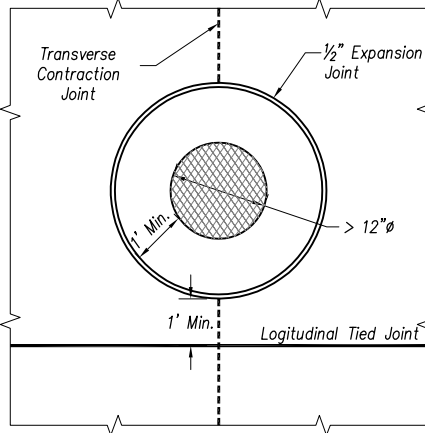

Boxout for Casting in Pavement

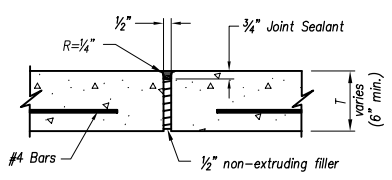
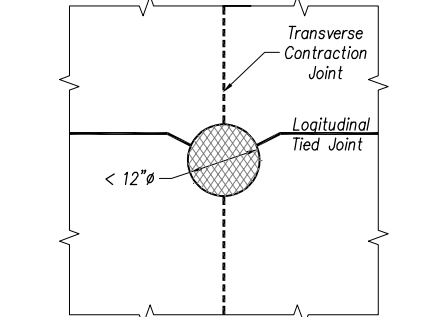
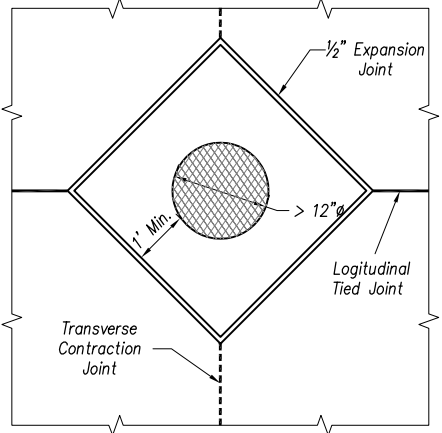

Expansion Joint

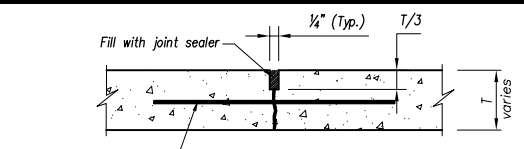

Logitudinal Tied Joint

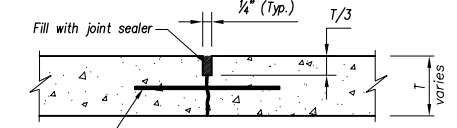

Transverse Contraction Joint

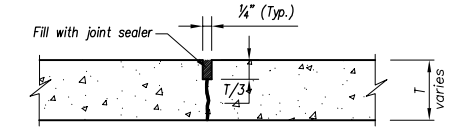

Untied Contraction Joint

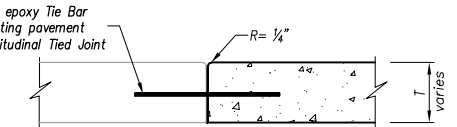

Logitudinal Construction Joint

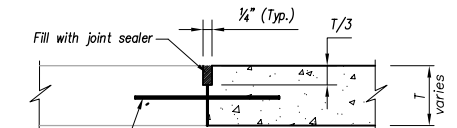

Transverse Construction Joint

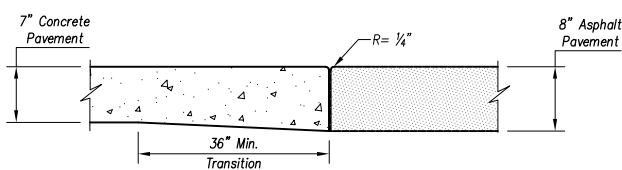

Isolation Joint at Residential Asphalt Street

Joint Details

(Δ) - no Dowel Bars when T ≤ 7"

Note: Tie bars shall be greater than 12" from end of Dowel Bars.

Dowel Size	
T (in.)	Diameter
T ≤ 7	No Dowels Required
7 < T < 9	1"
T ≥ 9	1 1/4"

The Contractor shall submit a final jointing plan to the City two weeks prior to beginning of pavement construction. No concrete pavement shall be constructed without prior approval of the jointing plan by the City Engineer.

REVISIONS:	
RELATED ORDINANCES:	
OPMC Title 13	

Year 2022 Edition

OVERLAND PARK
KANSAS
ABOVE AND BEYOND. BY DESIGN.

DEPARTMENT OF PUBLIC WORKS
STANDARD DETAILS

CONCRETE JOINT LAYOUT