

**PIPE UNDERDRAIN LATERAL A-A**

Not to Scale

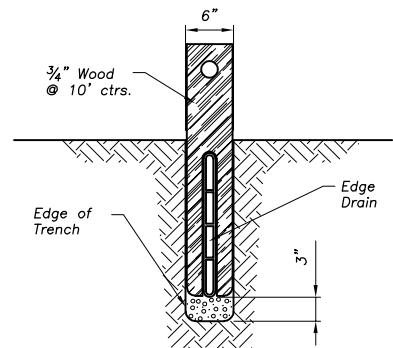

**EDGE UNDERDRAIN TEMPORARY SUPPORT DETAIL**

Not to Scale

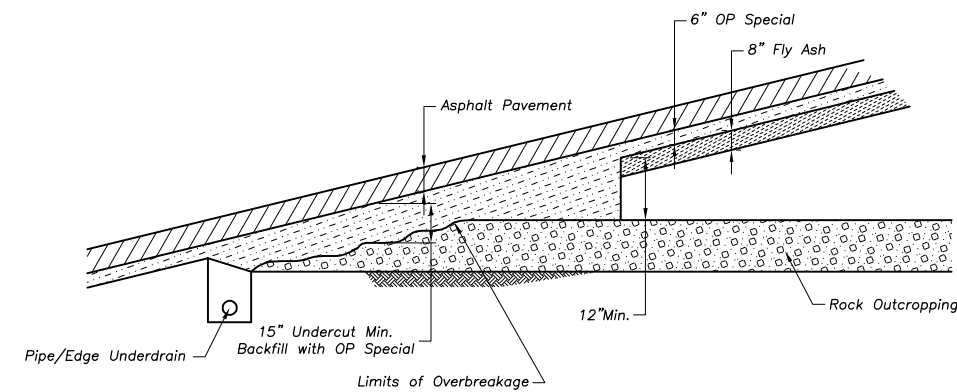

**ROCK OUTCROPPING**

Not to Scale

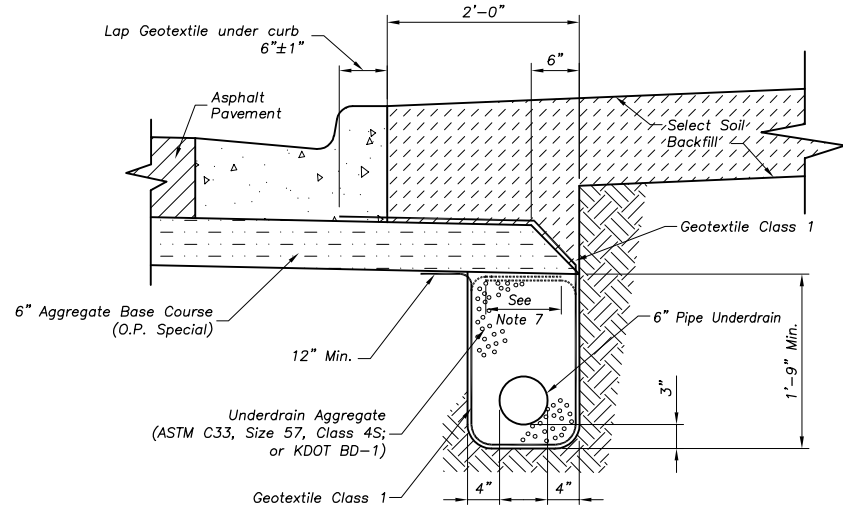

**PIPE UNDERDRAIN BEHIND CURB B-B**

Not to Scale

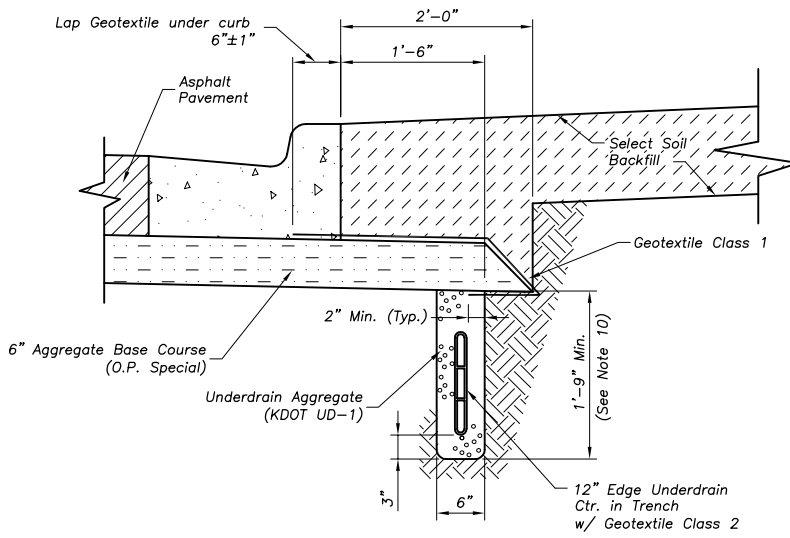

**EDGE UNDERDRAIN BEHIND CURB B-B**

Not to Scale

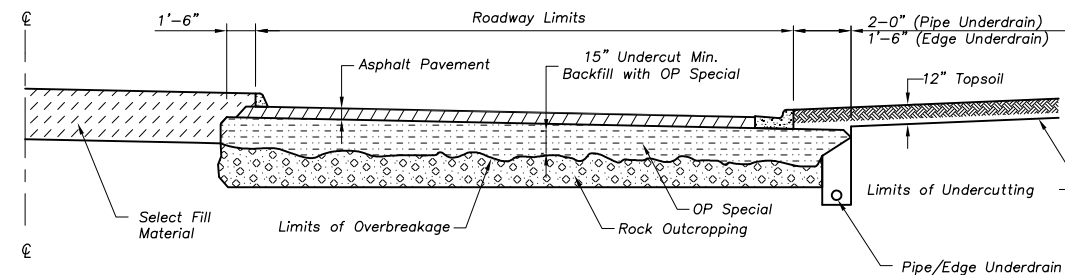

**ROCK EXCAVATION/AGGREGATE BASE COURSE**

Not to Scale

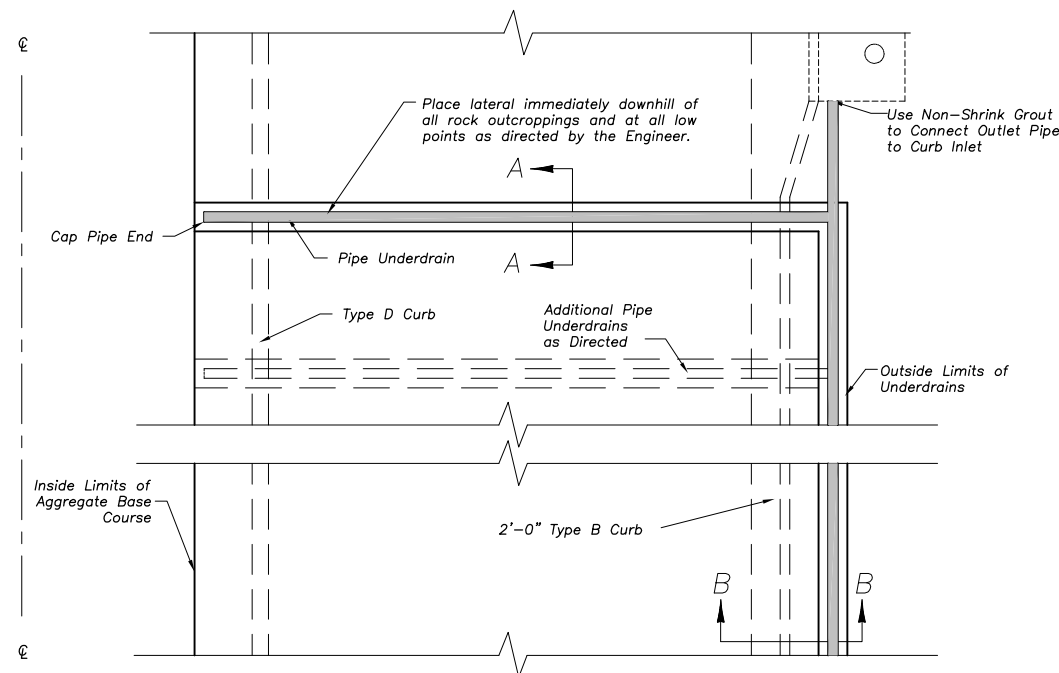

**UNDERDRAIN LAYOUT**

Not to Scale

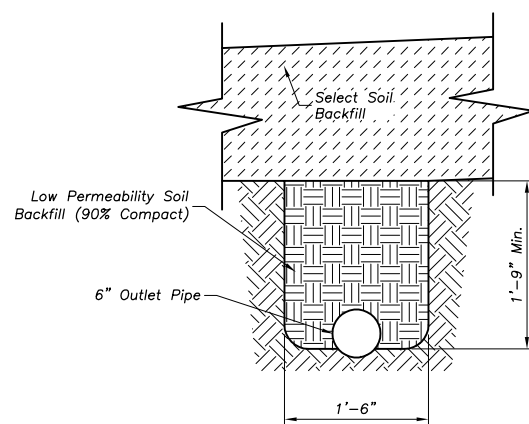

**OUTLET PIPE**

Not to Scale

**Underdrain Notes:**

- Overland Park Municipal Code (OPMC) and Overland Park Design and Construction Standards Manual (OPDCSM) are incorporated, except as otherwise noted.
- All roadway excavation in rock will be undercut no less than 15" below bottom of pavement for the full width of the roadway as shown. Undercut and overbreakage in limestone and durable shale shall be backfilled with material meeting the requirements of Aggregate Base Course (O.P. Special) Specifications. Layers of earth or shale shall not be permitted for backfill up to the bottom of the Aggregate Base Course.
- A minimum of 12" of select soil (topsoil) shall be placed on exposed rock cut or fill slopes outside the limits of the roadway. All rock and shale slopes shall be benched at a maximum of 2' vertical intervals prior to placement of select soil.
- Proposed underdrain pipe layout, flowline elevations, inlet connection points, and details shall be approved prior to construction by the City Engineer.
- Where pipe underdrains are used, all underdrain outlet pipes shall have watertight joints. All outlet pipes shall be tied into the nearest storm sewer inlet as approved. Where edge underdrains are used, all underdrain outlet pipes shall have manufacturer joints approved by the City Engineer. All connections between underdrain pipes and edge connectors or curb inlets shall be made with 2' length of outlet pipe.
- All underdrain pipes shall be installed at a minimum slope of 1%. Pipe shall be installed with the perforations placed down.
- Construct underdrain and fold geotextile over underdrain aggregate to protect the underdrain until the Aggregate Base Course is constructed. Fold the geotextile back and construct the Aggregate Base Course. Geotextile seams shall be overlapped at a minimum of 12".
- The contractor shall not mix underdrain types of materials within any underdrain system.
- All edge underdrain shall be held in the center of the trench by mechanical methods while placing granular backfill. See detail this sheet. Alternate methods may be used with prior approval by the City Engineer.
- Where edge underdrain crosses non-invasive detector loop conduit, the contractor shall lower the edge drain up to 7" to avoid conflict while maintaining positive drainage as otherwise indicated in these construction notes.
- See Approved Materials List for pre-approved Geotextile Class 1 and Class 2.

**UNDERDRAIN**

Year 2022 Edition

REVISIONS:	
Jan. 2006	Notes
Feb. 2008	Miscellaneous
RELATED ORDINANCES:	
OPMC Title 13;	
OPMC Title 15;	

**OVERLAND PARK**  
KANSAS

ABOVE AND BEYOND. BY DESIGN.

DEPARTMENT OF PUBLIC WORKS  
STANDARD DETAILS

**UNDERDRAIN - ASPHALT ROADWAY**